

KTS @ web

Login

kts.kreativkonzentrat.de
/wp-admin

[:de] Mehrsprachigkeit

[:en] Multilanguage

Konsistenz

Produktbilder

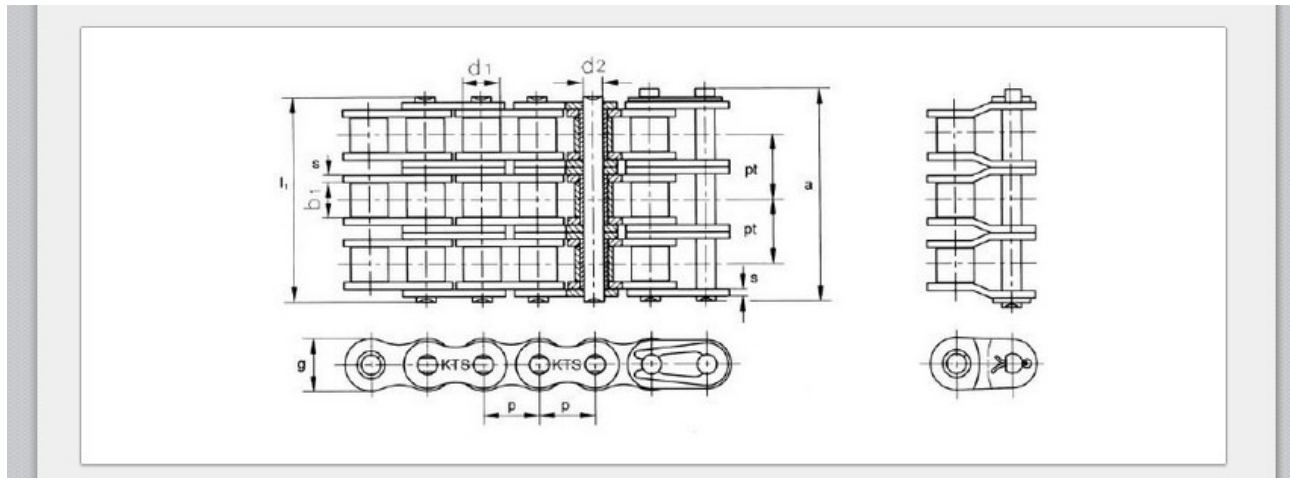

RICHTIG

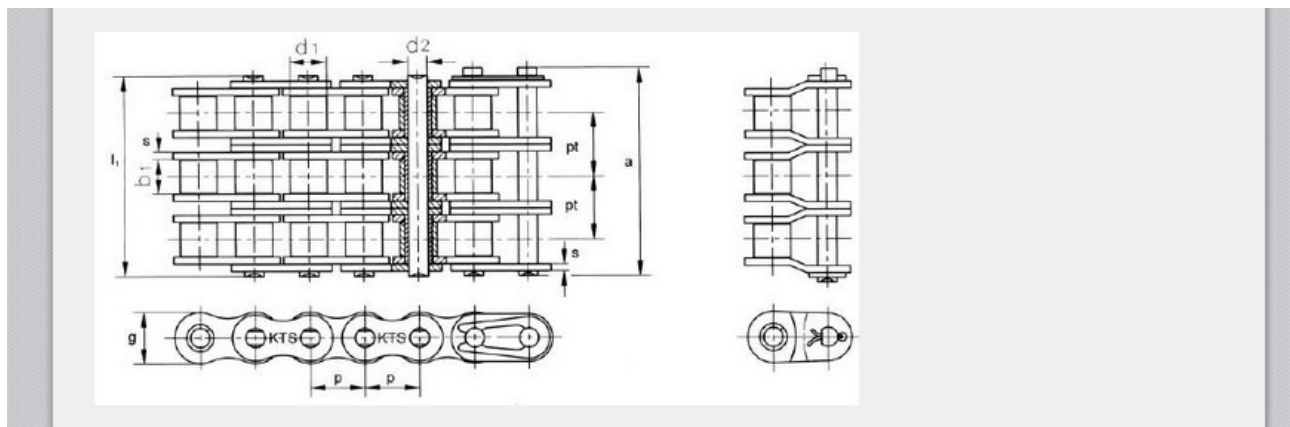

FALSCH

Auflistungen

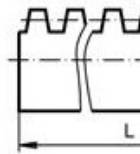

Gerade verzahnt
Eingriffswinkel 20°
Toleranz je Teilung +/- 20 µm
Zahnflanken nicht geschliffen

F
A
L
S
C
H

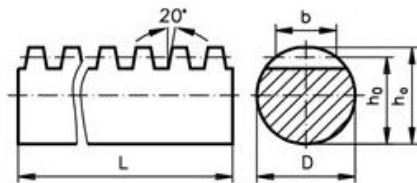

Gerade verzahnt
Eingriffswinkel 20°
Toleranz je Teilung +/- 20 µm
Zahnflanken nicht geschliffen

RICHTIG

- ISO-Nr.: 12 B-1 (3/4" x 7/16")
- Teilung: 19,05 mm
- lichte Weite: 11,68 mm
- Rollen-Durchmesser : 12,07 mm
- Zahnbreite bf1 11,1 mm
- ba 2 mm (Abfasung der Zahnbreite)
- rx 19 mm (min. Zahnfasenradius)

Tabellen

Zähne-	Teilkreis	Kopfkreis	Naben	
zahl	∅	∅	∅	
z	d ₀	d _k	d _n	
Material Stahl/C45				
8	49,8	57	31	
9	55,7	62	37	
10	61,6	69	42	

FALSCH

Zähne-	Teilkreis	Kopfkreis	Naben	
zahl	∅	∅	∅	
z	d ₀	d _k	d _n	
Material Stahl/C45				
8	49,8	57	31	
9	55,7	62	37	

RICHTIG

<div> ... </div>

h1, p, **div**, a, img

<div>A</div>
<div>B</div>

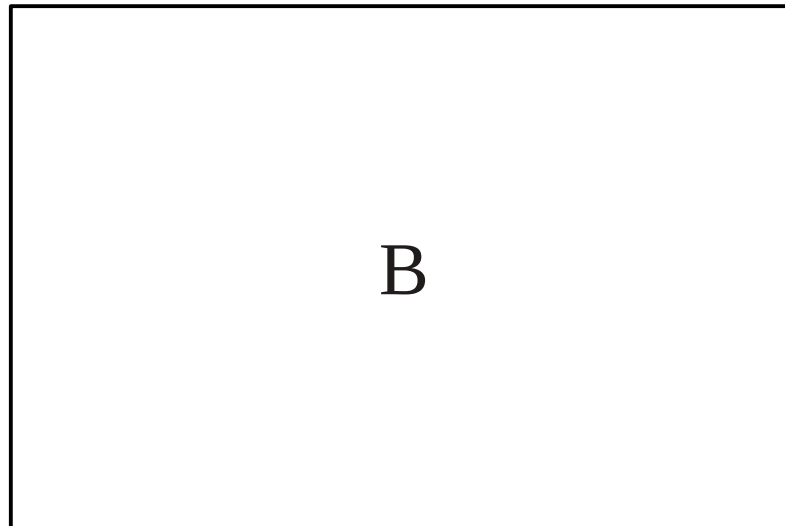
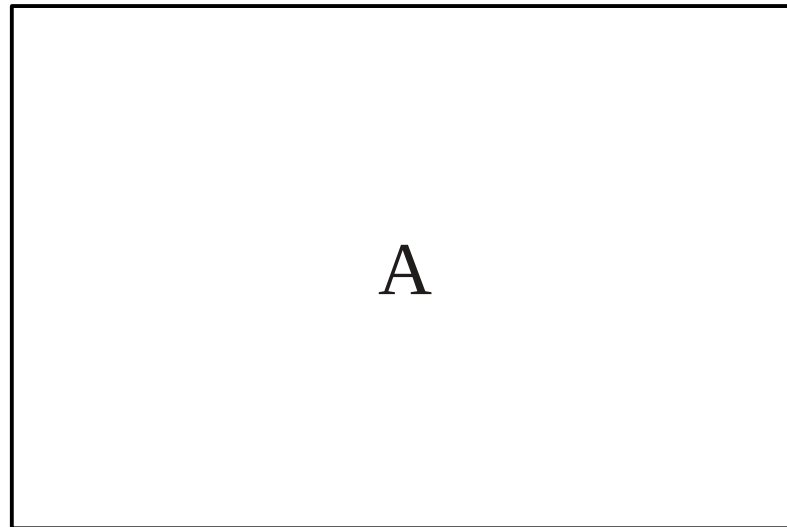

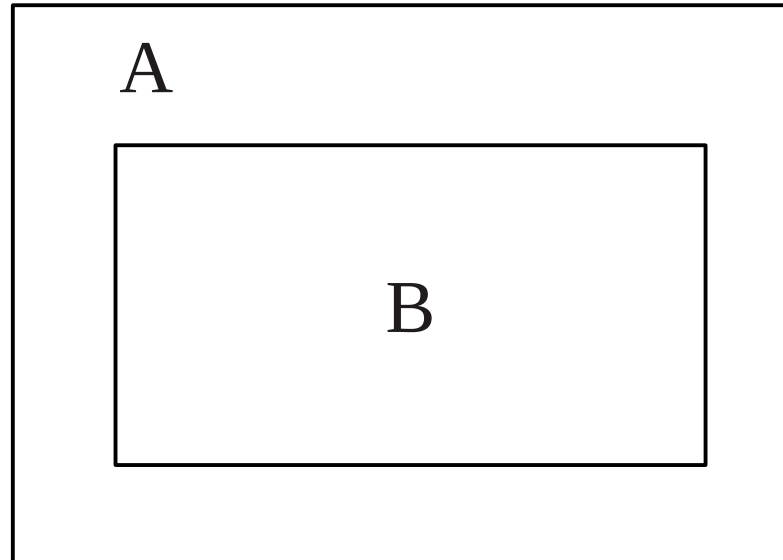

```
<div>A  
  <div>B</div>  
</div>
```

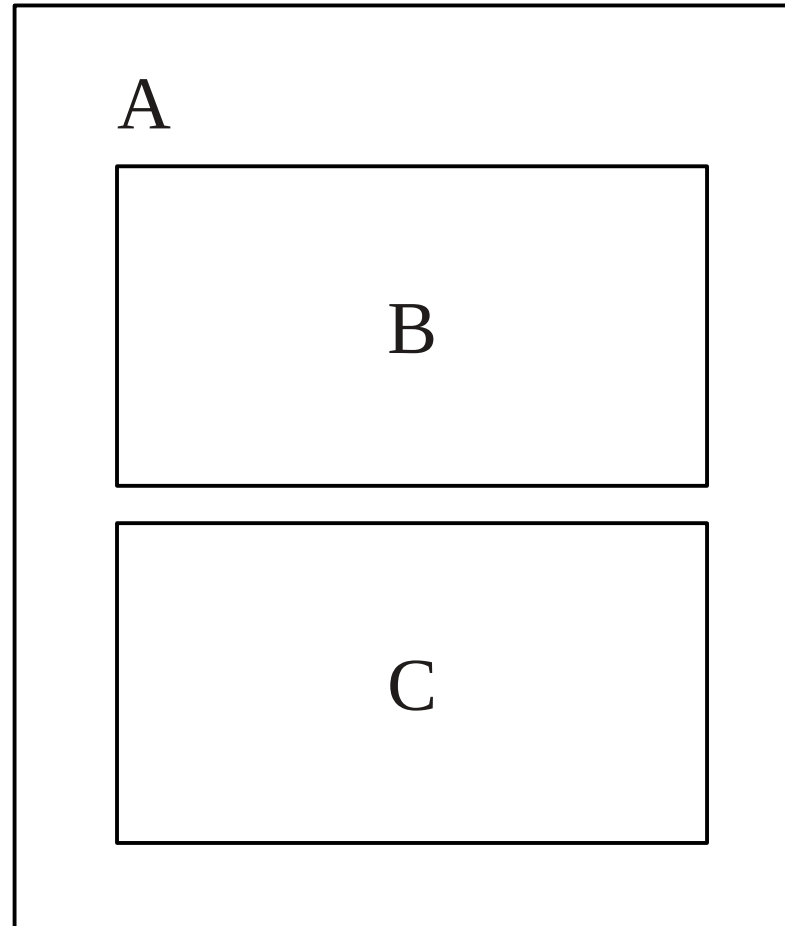

```
<div>A  
  <div>B</div>  
  <div>C</div>  
</div>
```

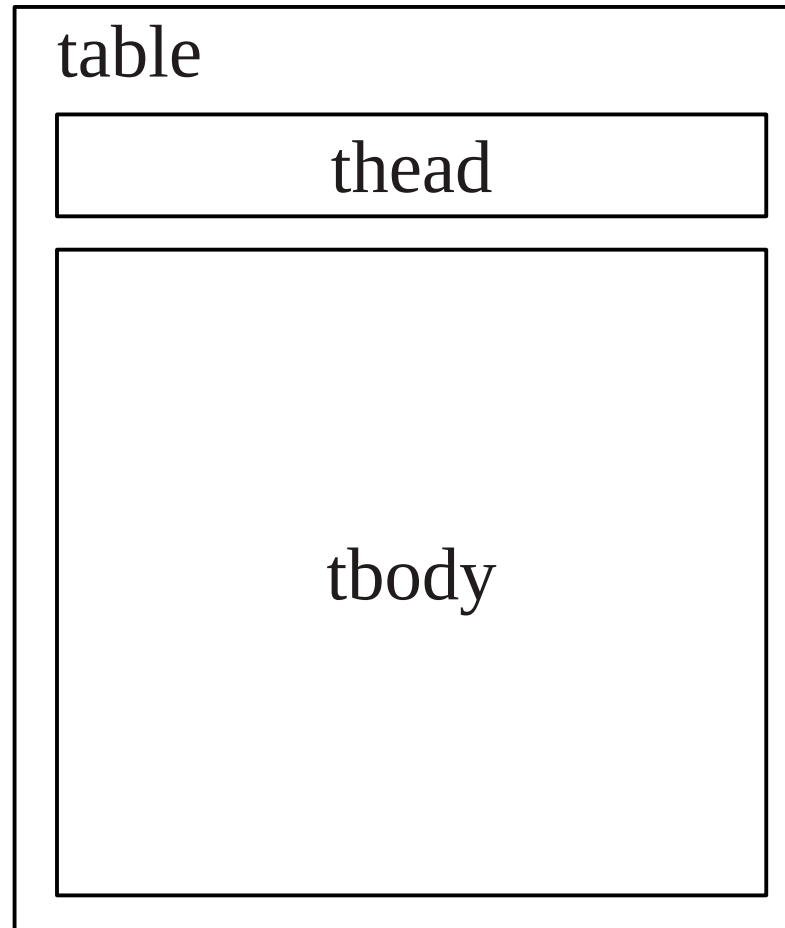

```
<table>  
  <thead>...</thead>  
  <tbody>...</tbody>  
</table>
```



und sonst so?

mail: martin@kreativkonzentrat.de